

# Tensile testing of metallic materials —

## Part 5: Method of test at elevated temperatures

The European Standard EN 10002-5:1991 has the status of a  
British Standard

## Cooperating organizations

The European Committee for Standardization (CEN), under whose supervision this European Standard was prepared, comprises the national standards organizations of the following countries:

Austria	Oesterreichisches Normungsinstitut
Belgium	Institut belge de normalisation
Denmark	Dansk Standardiseringsraad
Finland	Suomen Standardisoimisliitto, r.y.
France	Association française de normalisation
Germany	Deutsches Institut für Normung e.V.
Greece	Hellenic Organization for Standardization
Iceland	Technological Institute of Iceland
Ireland	National Standards Authority of Ireland
Italy	Ente Nazionale Italiano di Unificazione
Luxembourg	Inspection du Travail et des Mines
Netherlands	Nederlands Normalisatie-instituut
Norway	Norges Standardiseringsforbund
Portugal	Instituto Português da Qualidade
Spain	Asociación Española de Normalización y Certificación
Sweden	Standardiseringskommissionen i Sverige
Switzerland	Association suisse de normalisation
United Kingdom	British Standards Institution

This British Standard was published under the authority of the Standards Board and comes into effect on 1 April 1992

© BSI 04-1999

The following BSI references relate to the work on this standard:  
Committee reference ISM/NFM/4  
Draft for comment 88/37338 DC

ISBN 0 580 20403 0

### Amendments issued since publication

Amd. No.	Date	Comments

---

# Contents

	Page
Cooperating organizations	Inside front cover
National foreword	ii
<hr/>	
Foreword	2
Text of EN 10002-5	5
National annex NA (informative)	Inside back cover
National annex NB (informative)	Inside back cover

---

## National foreword

This British Standard has been prepared under the direction of the Iron and Steel and the Non-ferrous Metals Standards Policy Committees. It is identical with EN 10002-5 *“Metallic materials — Tensile testing — Part 5: Method of testing at elevated temperature”* drawn up by ECISS (European Committee for Iron and Steel Standardization).

It supersedes BS 3688-1:1963 which is withdrawn.

**Cross-references.** Details of European Standards quoted in this British Standard for which there is a corresponding British Standard are given in National appendix NB.

A British Standard does not purport to include all the necessary provisions of a contract. Users of British Standards are responsible for their correct application.

**Compliance with a British Standard does not of itself confer immunity from legal obligations.**

### Summary of pages

This document comprises a front cover, an inside front cover, pages i and ii, the EN title page, pages 2 to 26, an inside back cover and a back cover.

This standard has been updated (see copyright date) and may have had amendments incorporated. This will be indicated in the amendment table on the inside front cover.

EUROPEAN STANDARD

EN 10002-5

NORME EUROPÉENNE

EUROPÄISCHE NORM

October 1991

---

UDC 669:620.172.251.2

Descriptors: Metal products, mechanical tests, tension tests, high temperature tests, definitions, designation, test specimen, testing conditions, elongation at break, elastic limit

English version

## Metallic materials — Tensile testing — Part 5: Method of testing at elevated temperature

Matériaux métalliques — Essai de traction —      Metallische Werkstoffe — Zugversuch —  
Partie 5: Méthode d'essai à température élevée      Teil 5: Prüfverfahren bei erhöhter Temperatur

This European Standard was approved by CEN on 9 October 1991. CEN members are bound to comply with the CEN/CENELEC Internal Regulations which stipulate the conditions for giving this European Standard the status of a national standard without any alteration.

Up-to-date lists and bibliographical references concerning such national standards may be obtained on application to the Central Secretariat or to any CEN member.

This European Standard exists in three official versions (English, French, German). A version in any other language made by translation under the responsibility of a CEN member into its own language and notified to the Central Secretariat has the same status as the official versions.

CEN members are the national standards bodies of Austria, Belgium, Denmark, Finland, France, Germany, Greece, Iceland, Ireland, Italy, Luxembourg, Netherlands, Norway, Portugal, Spain, Sweden, Switzerland and United Kingdom.

# CEN

European Committee for Standardization  
Comité Européen de Normalisation  
Europäisches Komitee für Normung

**Central Secretariat: rue de Stassart 36, B-1050 Brussels**

**Foreword**

This European Standard was prepared by the Technical Committee ECISS/TC1A "Mechanical and physical tests", the Secretariat of which has been allocated to the Association Française de Normalisation (AFNOR).

It represents the fifth part of the general standard: Metallic materials — Tensile testing.

This European Standard replaces the EURONORM: EU 2270 Determination or verification of the yield point of steel at elevated temperatures.

This European Standard EN 10002-5 was approved by CEN on 1991-08-05.

According to the Common CEN/CENELEC Rules, being part of the Internal Regulations of CEN, the following countries are bound to implement this European Standard:

Austria, Belgium, Denmark, Finland, France, Germany, Greece, Iceland, Italy, Luxembourg, Netherlands, Norway, Portugal, Spain, Sweden, Switzerland and United Kingdom.

**Contents**

	Page
Foreword	2
Introduction	5
1 Scope	5
2 Normative references	5
3 Principle	5
4 Definitions	5
4.1 Gauge length ( $L$ )	5
4.2 Parallel length ( $L_0$ )	5
4.3 Elongation	5
4.4 Percentage elongation	5
4.5 Extensometer gauge length	6
4.6 Extension	6
4.7 Percentage reduction of area ( $Z$ )	6
4.8 Maximum force ( $F_m$ )	6
4.9 Stress	6
5 Symbols and designations	7
6 Test pieces	7
6.1 Shape and dimensions	7
6.2 Types	7
6.3 Preparation of test pieces	7
7 Determination of original cross-sectional area ( $S_0$ )	7
8 Marking the original gauge length ( $L_0$ )	9
9 Testing apparatus	9
9.1 Testing machine	9
9.2 Extensometer	9
9.3 Heating device	9
10 Conditions of testing	10
10.1 Heating of the test piece	10
10.2 Loading of the test piece	10
10.3 Rate of the loading	10
10.4 Method of gripping	10
11 Determination of percentage elongation after fracture ( $A$ )	10
12 Determination of proof strength (non-proportional extension ( $R_p$ ))	11
13 Determination of proof strength (total extension) ( $R_t$ )	11
14 Method of verification of permanent set strength ( $R_r$ )	12
15 Test report	12

	Page		Page
Annex A (Normative annex) Types of test piece to be used for thin products: sheets, strips and flats between 0.1 mm and 3 mm	20	Table 1 — Symbols and designations	8
Annex B (Normative annex) Types of test piece to be used in the case of wire, bars and sections with a diameter or thickness of less than 4 mm	21	Table 2 — Product types	9
Annex C (Normative annex) Types of test piece to be used in the case of sheets and flats of thickness equal to or greater than 3 mm, and wire, bars and sections of diameter or thickness equal to or greater than 4 mm	21	Table A1 — Dimensions of test pieces	20
Annex D (Normative annex) Types of test piece to be used in the case of tubes	23	Table A2 — Tolerances on the width of the test piece	20
Annex E (Normative annex) Measurement of percentage elongation after fracture, based on sub-division of the original gauge length	24	Table C1 — Circular cross-section test pieces	22
Annex F (Informative annex) List of national standards corresponding to reference Euronorm 18	25	Table C2 — Tolerances relating to the transverse dimensions of test pieces	22
Annex G (Informative annex) Bibliography	25	Table F1 — National standards corresponding to Euronorm 18	26
Figure 1 — Definitions of elongation	12		
Figure 2 — Definitions of upper and lower yield strength for different types of curve	13		
Figure 3 — Proof strength, non-proportional extension ( $R_p$ )	14		
Figure 4 — Proof strength, total extension ( $R_t$ )	14		
Figure 5 — Permanent set strength ( $R_r$ )	15		
Figure 6 — Proof strength, non-proportional extension ( $R_p$ )	15		
Figure 7 — Lower yield strength ( $R_{eL}$ )	16		
Figure 8 — Maximum force ( $F_m$ )	16		
Figure 9 — Machined test pieces of rectangular cross section (see Annex A)	17		
Figure 10 — Test pieces comprising a non-machined portion of the product (see Annex B)	17		
Figure 11 — Proportional test pieces (see Annex C)	18		
Figure 12 — Test pieces comprising a length of tube (see Annex D)	18		
Figure 13 — Test piece cut from a tube (see Annex D)	19		
Figure E1 — Example of elongation measurement after fracture	25		



## Introduction

The Standard EN 10002 will comprise the following parts:

- *Part 1: Metallic materials; Tensile test; Method of test (at ambient temperature);*
- *Part 2: Metallic materials; tensile test; Verification of the force measuring system of the tensile testing machine;*
- *Part 3: Metallic materials; Tensile test; Calibration of proving devices used for the verification of uniaxial testing machines;*
- *Part 4: Metallic materials; Tensile test; Verification of extensometers used in uniaxial testing;*
- *Part 5: Metallic materials; Tensile test; Method of test at elevated temperatures.*

## 1 Scope

This European Standard specifies the method for tensile testing of metallic materials and defines the mechanical properties which can be determined thereby at elevated temperature.

For certain particular metallic materials and applications, the tensile test may be the subject of specific standards or particular requirements. It should be noted that tests carried out at the same temperature in accordance with the tensile testing method at ambient temperature (EN 10002/1) and this standard should give different results by reason of different testing conditions, for example the loading rate (see Annex G).

A harmonising of the two tests operating conditions should be envisaged on the occasion of the next revision of the corresponding standards.

## 2 Normative references

EN 10002-1, *Metallic materials — Tensile testing — Part 1: Method of test at ambient temperature.*

EN 10002-2, *Tensile testing — Verification on the load cell of tensile testing machine.*

ISO 2566-1, *Steel — Conversion of elongation values — Part 1: Carbon and low alloy steels.*

ISO 2566-2, *Steel — Conversion of elongation values — Part 2: Austenitic steels.*

EN 10002-4<sup>1)</sup>, *Metallic materials — Verification of extensometers used in uniaxial testing.*

EU 18-1979<sup>2)</sup>, *Selection and preparation of samples and test pieces for steel and iron and steel products.*

<sup>1)</sup> In preparation.

<sup>2)</sup> Until this Euronorm is transformed into European Standards, it can either be used or reference made to the corresponding national standards, a list of which is given in Annex F of this European Standard.

## 3 Principle

The test involves straining a test piece by tensile force, generally to fracture, for the purpose of determining one or more of the mechanical properties defined in clause 4.

The test is carried out at the specified temperature.

## 4 Definitions

For the purposes of this European Standard, the following definitions apply.

### 4.1 gauge length ( $L$ )

Length of the cylindrical or prismatic portion of the test piece on which elongation is measured at any moment during the test. In particular, a distinction is made between:

#### 4.1.1

##### original gauge length ( $L_0$ )

gauge length before heating of the test piece and before application of force

#### 4.1.2

##### final gauge length ( $L_u$ )

gauge length after rupture of the test piece (see 11.1). This length shall be measured at ambient temperature

#### 4.2

##### parallel length ( $L_c$ )

length of the reduced section parallel portion of the test piece

NOTE The concept of parallel length is replaced by the concept of distance between grips for non-machined test pieces.

#### 4.3

##### elongation

increase in the original gauge length ( $L_0$ ) at the end of the test

#### 4.4 percentage elongation

Elongation expressed as a percentage of the original gauge length ( $L_0$ ).

#### 4.4.1

##### percentage permanent elongation

increase in the original gauge length of a test piece after removal of a specified stress (see 4.9), expressed as a percentage of the original gauge length ( $L_0$ )

#### 4.4.2 percentage elongation after fracture ( $A$ )

permanent elongation of the gauge length after fracture ( $L_u - L_0$ ) expressed as a percentage of the original length ( $L_0$ )

NOTE In the case of proportional test pieces, only if the original gauge length is other than  $5,65\sqrt{S_0}$ ,<sup>3)</sup> where  $S_0$  is the original cross-sectional area of the parallel length, the symbol  $A$  shall be supplemented by an index indicating the coefficient of proportionality used, for example:

$A_{11,3}$  = percentage elongation on a gauge length ( $L_0$ ) of  $11,3\sqrt{S_0}$

In the case of non-proportional test pieces, the symbol  $A$  shall be supplemented by an index indicating the original gauge length used, expressed in millimetres, for example:

$A_{80}$  mm = percentage elongation on a gauge length ( $L_0$ ) of 80 mm.

#### 4.4.3 percentage total elongation at fracture ( $A_t$ )

total elongation (elastic elongation plus plastic elongation) of the gauge length at the moment of fracture expressed as a percentage of the original gauge length ( $L_0$ )

#### 4.5 extensometer gauge length ( $L_e$ )

length of the parallel portion of the test piece used for the measurement of extension by means of an extensometer (this length may differ from  $L_0$  and shall be of any value greater than  $b$ ,  $d$  or  $D$  (see Table 1) but less than the parallel length ( $L_0$ ))

#### 4.6 extension

Increase in the extensometer gauge length ( $L_e$ ) at a given moment of the test.

##### 4.6.1 percentage permanent extension

increase in the extensometer gauge length after removal from the test piece of a specified stress, expressed as a percentage of the extensometer gauge length ( $L_e$ )

##### 4.6.2 percentage yield point extension ( $A_e$ )

extension between the start of yielding giving localized deformation and the commencement of homogeneous deformation giving smooth work hardening. It is expressed as a percentage of the extensometer gauge length ( $L_e$ )

#### 4.7 percentage reduction of area ( $Z$ )

maximum change in cross-sectional area which has occurred during the test ( $S_0 - S_u$ ) expressed as a percentage of the original cross-sectional area ( $S_0$ )

<sup>3)</sup>  $5,65\sqrt{S_0} = 5\sqrt{\frac{4S_0}{\pi}}$

#### 4.8 maximum force ( $F_m$ )

the greatest force which the test piece withstands during the test once the yield point has been passed

#### 4.9 stress

Force at any moment during the test divided by the original cross-sectional area ( $S_0$ ) of the test piece.

##### 4.9.1 tensile strength ( $R_m$ )

stress corresponding to the maximum force ( $F_m$ )

##### 4.9.2 yield strength

When the metallic material exhibits a yield phenomenon, a point is reached during the test at which plastic deformation occurs without any increase in the force. A distinction is made between:

###### 4.9.2.1 upper yield strength ( $R_{eH}$ )

value of stress at the moment when the first decrease in force is observed (see Figure 2)

###### 4.9.2.2 lower yield strength ( $R_{eL}$ )

lowest value of stress during plastic yielding, ignoring any transient effects (see Figure 2)

##### 4.9.3 proof strength, non-proportional extension ( $R_p$ )

stress at which a non-proportional extension is equal to a specified percentage of the extensometer gauge length ( $L_e$ ) (see Figure 3). The symbol used is followed by a suffix giving the prescribed percentage of the extensometer gauge length, for example  $R_{p0,2}$

##### 4.9.4 proof strength, total extension ( $R_t$ )

stress at which total extension (elastic extension plus plastic extension) is equal to the specified percentage of the extensometer gauge length ( $L_e$ ) (see Figure 4). The symbol used is followed by a suffix giving the prescribed percentage of the original gauge length for example:  $R_{t0,5}$

##### 4.9.5 permanent set strength ( $R_r$ )

stress at which, after removal of force, a specified permanent elongation or extension expressed respectively as a percentage of the original gauge length ( $L_0$ ) or extensometer gauge length ( $L_e$ ) has not been exceeded (see Figure 5). The symbol used is followed by a suffix giving the specified percentage of the original gauge length or of the extensometer gauge length ( $L_e$ ), for example:  $R_{r0,2}$

## 5 Symbols and designations

Symbol and corresponding designations are given in Table 1.

## 6 Test pieces

### 6.1 Shape and dimensions

#### 6.1.1 General

The shape and dimensions of the test pieces depend on the shape and dimensions of the metallic products the mechanical properties of which are to be determined.

The test piece is usually obtained by machining a sample from the product or a pressed blank or casting. However products of constant cross-section (sections, bars, wires, etc.) and also as cast test pieces (i.e. cast irons and non-ferrous alloys) may be subjected to test without being machined.

The cross-section of the test pieces may be circular, square, rectangular, annular or, in special cases, of some other shape.

Test pieces, the original gauge length of which is related to the original cross-sectional area by the equation  $L_0 = k \sqrt{S_0}$  are called proportional test pieces. The internationally adopted value for  $k$  is 5,65. The original gauge length shall be not less than 20 mm. When the cross-sectional area of the test piece is too small for this requirement to be met with the coefficient  $k$  value of 5,65, a higher value (preferably 11,3) or a non-proportional test piece may be used.

In the case of non-proportional test pieces, the original gauge length ( $L_0$ ) is taken independently of the original cross-sectional area ( $S_0$ ).

The dimensional tolerances of the test pieces shall be in accordance with the appropriate annexes (see 6.2).

#### 6.1.2 Machined test pieces

Machined test pieces shall incorporate a transition curve between the gripped ends and the parallel length if these have different dimensions. The dimensions of this transition radius can be important and it is recommended that they be defined in the material specification if they are not given in the appropriate annex (see 6.2).

The gripped ends may be of any shape to suit the grips of the testing machine.

The parallel length ( $L_0$ ) or, in the case where the test piece has no transition curve, the free length between the grips, shall always be greater than the original gauge length ( $L_0$ ).

#### 6.1.3 Non-machined test pieces

If the test piece consists of an unmachined length of the product or of an unmachined test bar, the free length between the grips shall be sufficient for gauge marks to be at a reasonable distance from these grips.

As-cast test pieces shall incorporate a transition radius between the gripped ends and the parallel length. The dimensions of this transition radius are important and it is recommended that they be defined in the product standard. The gripped ends may be of any shape to suit the grips of the testing machine. The parallel length ( $L_0$ ) shall always be greater than the original gauge length ( $L_0$ ).

### 6.2 Types

The main types of test pieces are defined in Annex A to Annex D according to the shape and type of product, as shown in Table 2. Other types of test piece can be specified in product standards or by agreement.

### 6.3 Preparation of test pieces

The test pieces shall be taken and prepared in accordance with the requirements of the European Standards for the different materials (EU 18, etc.).

## 7 Determination of original cross-sectional area ( $S_0$ )

The original cross-sectional area shall be calculated from the measurements of the appropriate dimensions. The accuracy of this calculation depends on the nature and type of the test piece. It is indicated in Annex A to Annex D for the different types of test pieces.

Table 1 — Symbols and designations

Reference number <sup>a</sup>	Symbol	Unit	Designation
<i>Test piece</i>			
1	$a$	mm	Thickness of a flat test piece or wall thickness of a tube
2	$b$	mm	Width of the parallel length of a flat test piece or average width of the longitudinal strip taken from a tube or width of flat wire
3	$d$	mm	Diameter of the parallel length of a circular test piece, or diameter of round wire or internal diameter of a tube
4	$D$	mm	External diameter of a tube
5	$L_o$	mm	Original gauge length
6	$L_c$	mm	Parallel length
—	$L_e$	mm	Extensometer gauge length
7	$L_t$	mm	Total length of test piece
8	$L_u$	mm	Final gauge length after fracture
9	$S_o$	mm <sup>2</sup>	Original cross-sectional area of the parallel length
10	$S_u$	mm <sup>2</sup>	Minimum cross-sectional area after fracture
11	$Z$	%	Percentage reduction of area: $\left( \frac{S_o - S_u}{S_o} \right) 100$
12	—	—	Gripped ends
<i>Elongation</i>			
13	—	mm	Elongation after fracture: $L_u - L_o$
14	$A^b$	%	Percentage elongation after fracture: $\left( \frac{L_u - L_o}{L_o} \right) 100$
15	$A_e$	%	Percentage yield point extension
16	$A_t$	%	Percentage total elongation at fracture
17	—	%	Specified percentage non-proportional extension
18	—	%	Percentage total extension.
19	—	%	Specified percentage permanent set extension or elongation
<i>Force</i>			
20	$F_m$	N	Maximum force
<i>Yield strength — Proof strength — Tensile strength</i>			
21	$R_{eH}$	N/mm <sup>2</sup> <sup>c</sup>	Upper yield strength
22	$R_{eL}$	N/mm <sup>2</sup>	Lower yield strength
23	$R_m$	N/mm <sup>2</sup>	Tensile strength
24	$R_p$	N/mm <sup>2</sup>	Proof strength, non-proportional extension
25	$R_r$	N/mm <sup>2</sup>	Permanent set strength
26	$R_t$	N/mm <sup>2</sup>	Proof strength, total extension
<sup>a</sup> See Figure 1 to Figure 13. <sup>b</sup> See 4.4.2. <sup>c</sup> 1 N/mm <sup>2</sup> = 1 MPa.			

Table 2 — Product types

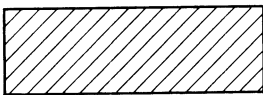
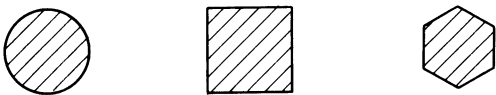
Type of product		Corresponding annexes
Sheets — flats  with a thickness in millimetres of	Wire — bars — sections  with a diameter or side in millimetres of	
0.1 ≤ thickness < 3	—	A
—	< 4	B
≥ 3	≥ 4	C
Tubes		

## 8 Marking the original gauge length ( $L_0$ )

Each end of the original gauge length shall be marked by means of fine marks, scribed lines, or fine collars but not by notches which could result in premature fracture.

For proportional test pieces, the calculated value of the original gauge length may be rounded off to the nearest multiple of 5 mm, provided that the difference between the calculated and marked gauge length is less than 10 % of  $L_0$ . The original gauge length shall be marked to an accuracy of  $\pm 1$  %.

If the parallel length ( $L_c$ ) is much in excess of the original gauge length, as, for instance, with unmachined test pieces, a series of overlapping gauge lengths shall be drawn; some of these lengths may extend up to the grips.

In some cases, it may be helpful to draw, on the surface of the test piece, a line parallel to the longitudinal axis, along which the marks are drawn.

## 9 Testing apparatus

### 9.1 Testing machine

The testing machine shall be verified in accordance with EN 10002-2 and shall be of grade 1 or better.

### 9.2 Extensometer

The extensometer used for measurement of the elongation shall be of class 1 (EN 10002-4<sup>4)</sup>) for the determination of upper and lower yield strengths and for proof strength (non-proportional extension); for other characteristics (with higher extension) a class 2 extensometer EN 10002-4 may be used.

The extensometer gauge length shall not be less than 10 mm and shall be centrally located in the mid-region of the parallel gauge length. The extensometer should be preferably of the type that is capable of measuring extension on both sides of a test piece and allowing the two readings to be averaged.

NOTE Any parts of the extensometer projecting beyond the furnace should be designed or protected from draughts so that fluctuations in the ambient temperature have only a minimal effect on the readings. It is advisable to maintain reasonable stability of the temperature and velocity of the air surrounding the testing machine.

### 9.3 Heating device

#### 9.3.1 Permitted deviations of temperature

The heating device for the test piece shall be such that the test piece can be heated to the specified temperature,  $\theta$ .

The permitted deviations between the specified temperature,  $\theta$ , and the indicated temperatures,  $\theta_i$ , are the following:

$\pm 3$ °C for	$\theta \leq 600$ °C
$\pm 4$ °C for 600 °C	$< \theta \leq 800$ °C
$\pm 5$ °C for 800 °C	$< \theta \leq 1\,000$ °C

For specified temperatures higher than 1 000 °C, the permitted deviations shall be defined by a previous agreement between the parties concerned.

The indicated temperatures,  $\theta_i$ , are the temperatures which are measured at the surface of the parallel length of the test piece.

The permitted deviations in temperature shall be complied with on the original gauge length,  $L_0$ , and at least until the point corresponding to the proof stress of non-proportional elongation is reached.

<sup>4)</sup> In preparation.

### 9.3.2 Measurement of temperature

Temperature-measuring equipment shall have a resolution of at least 1 °C and an accuracy of  $\pm 2$  °C.

NOTE Three thermocouples, which are arranged at identical intervals along the parallel length of the test piece, are generally sufficient to guarantee uniformity of the temperature of the test piece. This number may be reduced if the general arrangement of the furnace and the test piece is such that, from experience, it is known that the variation in temperature of the test piece does not exceed the permitted deviations specified in 9.3.1. Thermocouple junctions should make thermal contact with the surface of the test piece and be suitably screened from direct radiation from the furnace wall.

### 9.3.3 Verification of the temperature-measuring system

The temperature-measuring system, comprising sensors and read-out equipment, shall be verified over the working temperature range at intervals not exceeding one year; the errors shall be recorded in the verification report. Verification of the temperature-measuring system shall be carried out by a method traceable to the international unit (SI unit) of temperature.

## 10 Conditions of testing

### 10.1 Heating of the test piece

The test piece shall be heated to the specified temperature,  $\theta$ , and shall be maintained at that temperature for at least 10 min before loading. The loading shall only be started after the indications of the elongation-measuring apparatus have been stabilized.

During the heating, the temperature of the test piece shall not, at any moment, exceed the specified temperature with its tolerances, except by special agreement between the parties concerned.

When the test piece has reached the specified temperature, the extensometer shall be reset to zero.

### 10.2 Loading of the test piece

Force shall be applied so as to strain the test piece in a non-decreasing manner, without shock or sudden vibration. The force shall be applied along the specimen axis so as to produce minimum bending or torsion in the specimen gauge length<sup>5)</sup>.

### 10.3 Rate of the loading

#### 10.3.1 General

Unless otherwise specified in the product standard, the rate of the machine shall comply with the following requirements depending on the nature of the material.

#### 10.3.2 Determination of yield and proof strengths [upper and lower yield stresses, proof stress (non-proportional extension)]

The straining rate of the parallel length of the test piece, from the beginning of the test to the yield stress to be determined, shall be between 0,001 and 0,005 min<sup>-1</sup>.

NOTE In the case of machines unable to achieve the straining rate, the rate of stressing should be set so that the requirement that the straining rate be smaller than 0,003 min<sup>-1</sup> be complied with over the elastic range. In no case should the rate of stressing in the elastic range exceed 300 N/(mm<sup>2</sup> min).

#### 10.3.3 Determination of the tensile strength

If only the tensile strength is to be determined, the straining rate of the test piece shall be between 0,02 and 0,20 min<sup>-1</sup>.

If a yield stress is also determined on the same piece, the change of the stressing rate required in 10.3.2 to the rate defined in the paragraph above shall be monotonic.

### 10.4 Method of gripping

The test pieces shall be held by suitable means such as wedges, screwed holders, shouldered holders, hydraulic jacks, etc.

Every endeavour shall be made to ensure that test pieces are held in such a way that the force is applied as axially as possible. This is of particular importance when testing brittle materials or when determining proof strength (non-proportional extension) or proof strength (total extension) or yield strength.

## 11 Determination of percentage elongation after fracture (A)

11.1 Percentage elongation after fracture shall be determined in accordance with the definition given in 4.4.2.

For this purpose, the two broken pieces of the test piece are carefully fitted back together so that their axes lie in a straight line.

Special precautions shall be taken to ensure proper contact between the broken parts of the test piece when measuring the final gauge length. This is particularly important in the case of test pieces of small cross-section and test pieces having low elongation values.

<sup>5)</sup> Examples of methods for verifying alignment can be found in ASTM E 1012. Standard practice for verification and specimen alignment under tensile loading.

Elongation after fracture ( $L_u - L_0$ ) shall be determined to the nearest 0,25 mm with a measuring device with 0,1 mm resolution and the value of percentage elongation after fracture shall be rounded to the nearest 0,5 %. If the specified minimum percentage elongation is less than 5 %, it is recommended that special precautions are taken when determining elongation.

This measurement is, in principle, valid only if the distance between the fracture and the nearest gauge mark is not less than one third of the original gauge length ( $L_0$ ). However, the measurement is valid, irrespective of the position of the fracture, if the percentage elongation after fracture reaches at least the specified value and this shall be stated in the test report.

**11.2** For machines capable of measuring extension at fracture using an extensometer, it is not necessary to mark the gauge lengths. The elongation is measured as the total extension at fracture, and it is therefore necessary to deduct the elastic extension in order to obtain percentage elongation after fracture.

In principle, this measurement is only valid if fracture occurs within the extensometer gauge length ( $L_e$ ). The measurement is valid regardless of the position of the fracture cross-section if the percentage elongation after fracture at least reaches the specified value and this shall be stated in the test report.

NOTE If the product standard specifies the determination of percentage elongation after rupture for a given length, the extensometer gauge length shall be taken as equal to this length.

**11.3** If so permitted by the product standard, elongation may be measured over a given fixed length and converted to proportional gauge length using conversion formulae or tables as agreed before the commencement of testing (for example as in ISO 2566-1 and ISO 2566-2).

NOTE Comparisons of percentage elongation are possible only when the gauge length or extensometer gauge length, the shape and area of the cross-section are the same or when the coefficient of proportionality ( $k$ ) is the same.

**11.4** In order to avoid having to reject test pieces in which fracture may occur outside the limits specified in 11.1, the method based on the sub-division of  $L_0$  into  $N$  equal parts may be used, as described in Annex E.

## 12 Determination of proof strength (non-proportional extension) ( $R_p$ )

**12.1** The proof strength (non-proportional extension) is determined from the force/extension diagram by drawing a line parallel to the straight portion of the curve and at a distance from this equivalent to the prescribed non-proportional percentage, for example 0,2 %. The point at which this line intersects the curve gives the force corresponding to the desired proof strength (non-proportional extension). The latter is obtained by dividing this force by the original cross-sectional area of the test piece ( $S_0$ ) (see Figure 3).

Accuracy in drawing the force/extension diagram is essential.

If the straight portion of the force/extension diagram is not clearly defined, thereby preventing drawing the parallel line with sufficient precision, the following procedure is recommended (see Figure 6).

When the presumed proof strength has been exceeded, the force is reduced to a value equal to above 10 % of the force obtained. The force is then increased again until it exceeds the value obtained originally. To determine the desired proof strength a line is drawn through the hysteresis loop. A line is then drawn parallel to this line, at a distance from the origin of the curve, measured along the abscissa, equal to the prescribed non-proportional percentage. The intersection of this parallel line and the force/extension curve gives the force corresponding to the proof strength. The latter is obtained by dividing this force by the original cross-sectional area of the test piece ( $S_0$ ). (See Figure 6.)

**12.2** The property may be obtained without plotting the force/extension curve by using automatic devices (microprocessor, etc.).

## 13 Determination of proof strength (total extension) ( $R_t$ )

**13.1** The proof strength (total extension) is determined on the force/extension diagram by drawing a line parallel to the ordinate axis (force axis) and at a distance from this equivalent to the prescribed total percentage extension. The point at which this line intersects the curve gives the force corresponding to the desired proof strength. The latter is obtained by dividing this force by the original cross-sectional area of the test piece ( $S_0$ ) (see Figure 4).

**13.2** The property may be obtained without plotting the force/extension diagram by using automatic devices.

#### 14 Method of verification of permanent set strength ( $R_p$ )

The test piece is subjected to a force for 10 to 12 s unless otherwise specified in the product standard, corresponding to the specified stress and it is then confirmed, after removing the force, that the permanent set extension or elongation is not more than the percentage specified for the original gauge length.

#### 15 Test report

The test report shall contain at least the following information:

- reference to this standard, i.e. EN 10002-5
- identification of the test piece
- nature of the material, if known
- type of test piece and its size
- location and direction of sampling of test pieces
- the specified temperature of the test and the indicated temperatures, if outside the permitted limits
- characteristics measured and results.

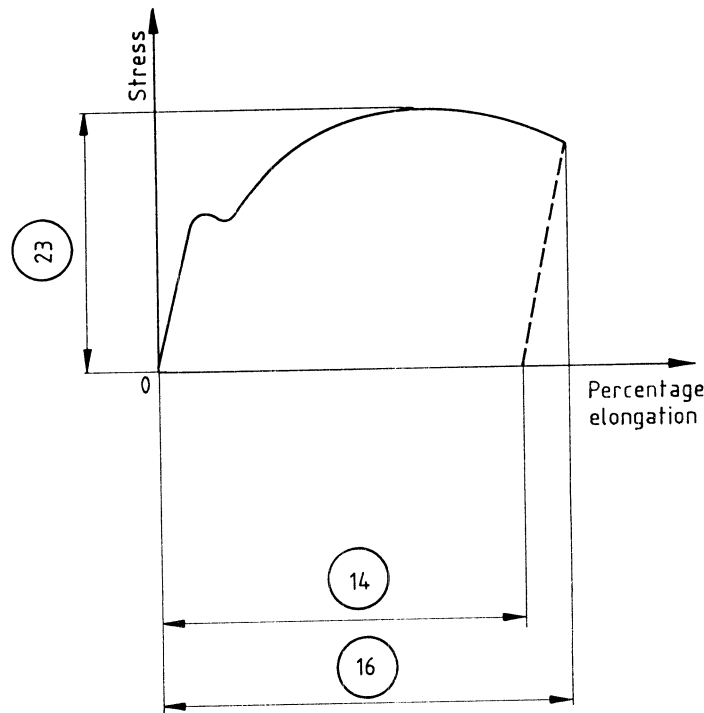

NOTE See Table 1 for explanation of reference numbers.

**Figure 1 — Definitions of elongation**

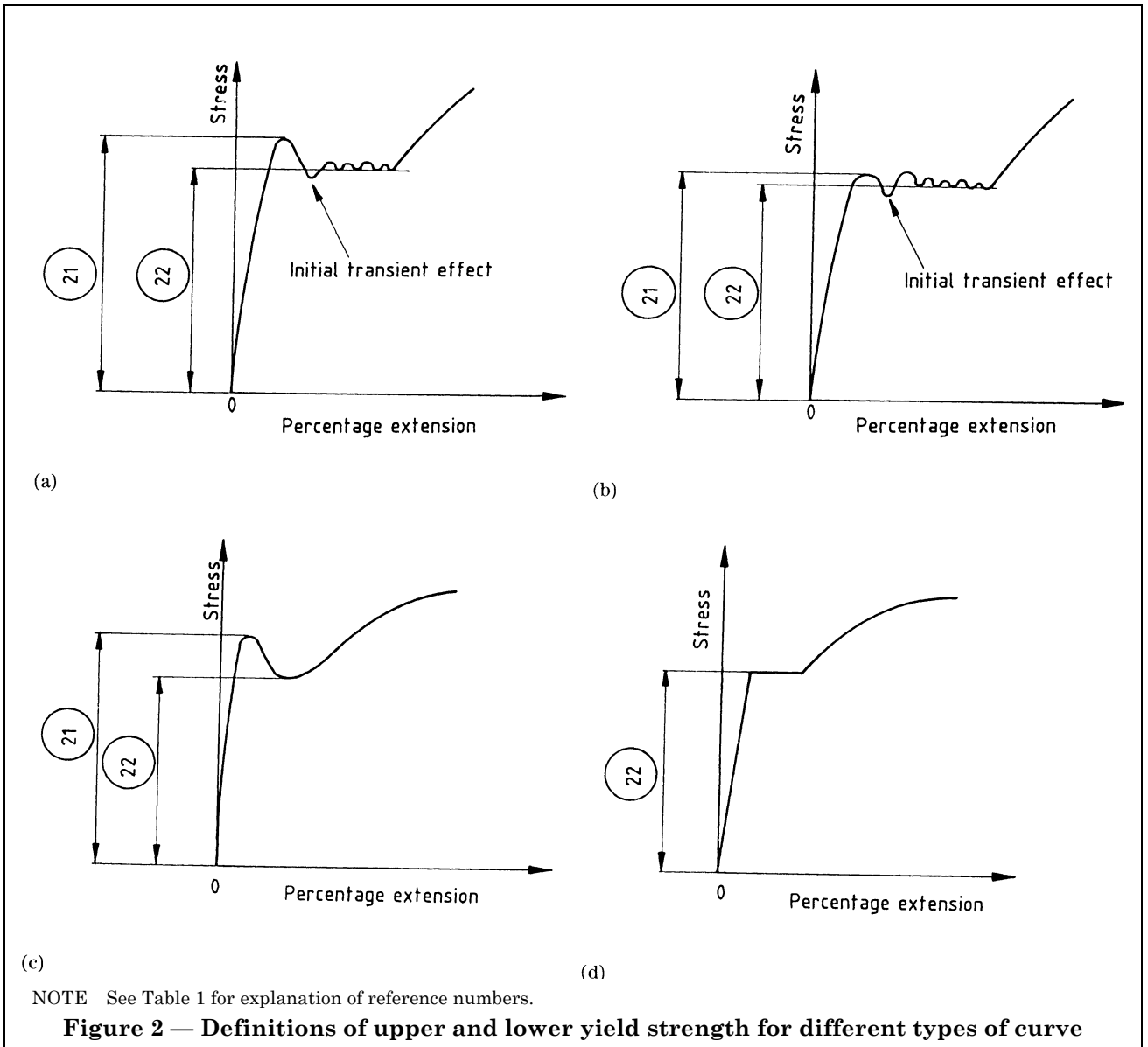

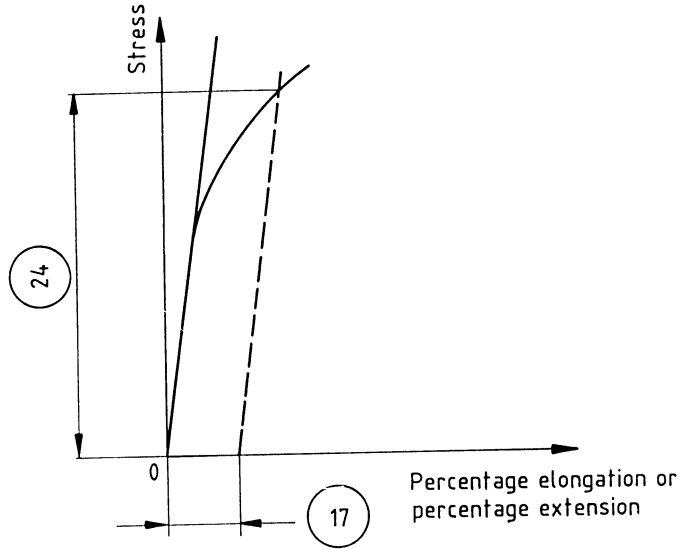

NOTE See Table 1 for explanation of reference numbers.

**Figure 3 — Proof strength, non-proportional extension ( $R_p$ )**

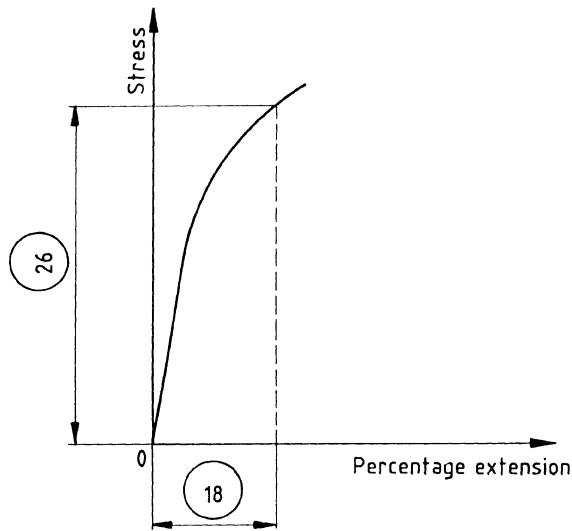

NOTE See Table 1 for explanation of reference numbers.

**Figure 4 — Proof strength, total extension ( $R_t$ )**

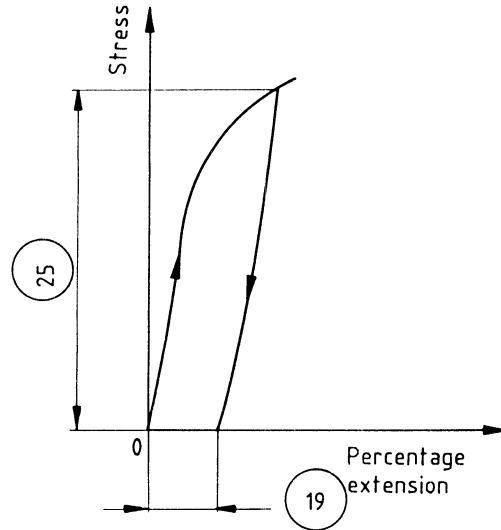

NOTE See Table 1 for explanation of reference numbers.

**Figure 5 — Permanent set strength ( $R_r$ )**

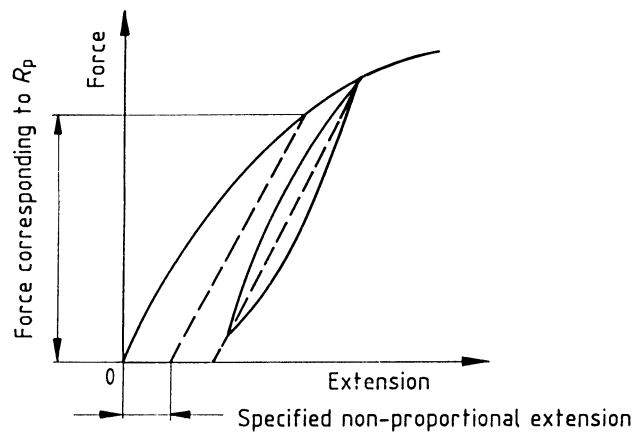

NOTE See Table 1 for explanation of reference numbers.

**Figure 6 — Proof strength, non-proportional extension ( $R_p$ ) (see 12.1)**

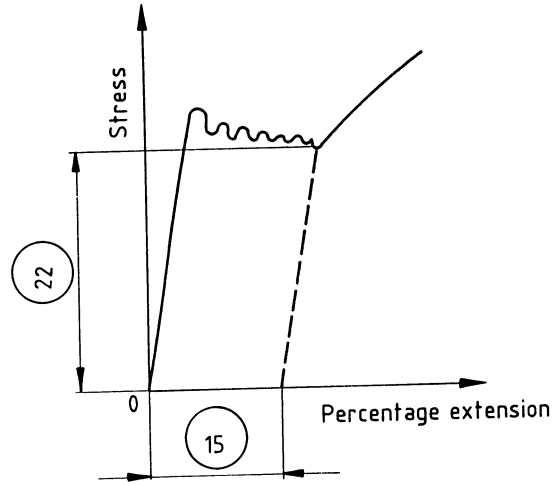

NOTE See Table 1 for explanation of reference numbers.

**Figure 7 — Lower yield strength ( $R_{eL}$ )**

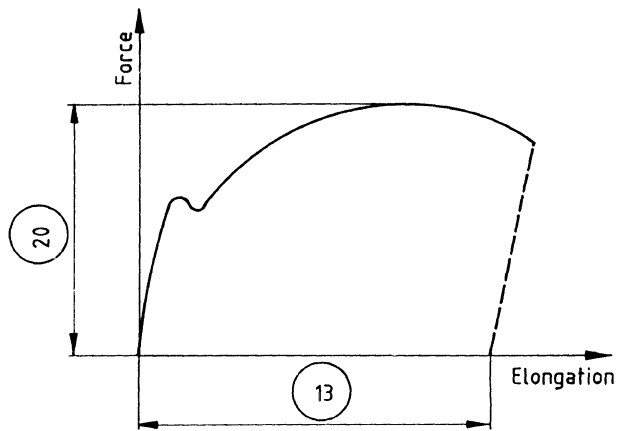

NOTE See Table 1 for explanation of reference numbers.

**Figure 8 — Maximum force ( $F_m$ )**

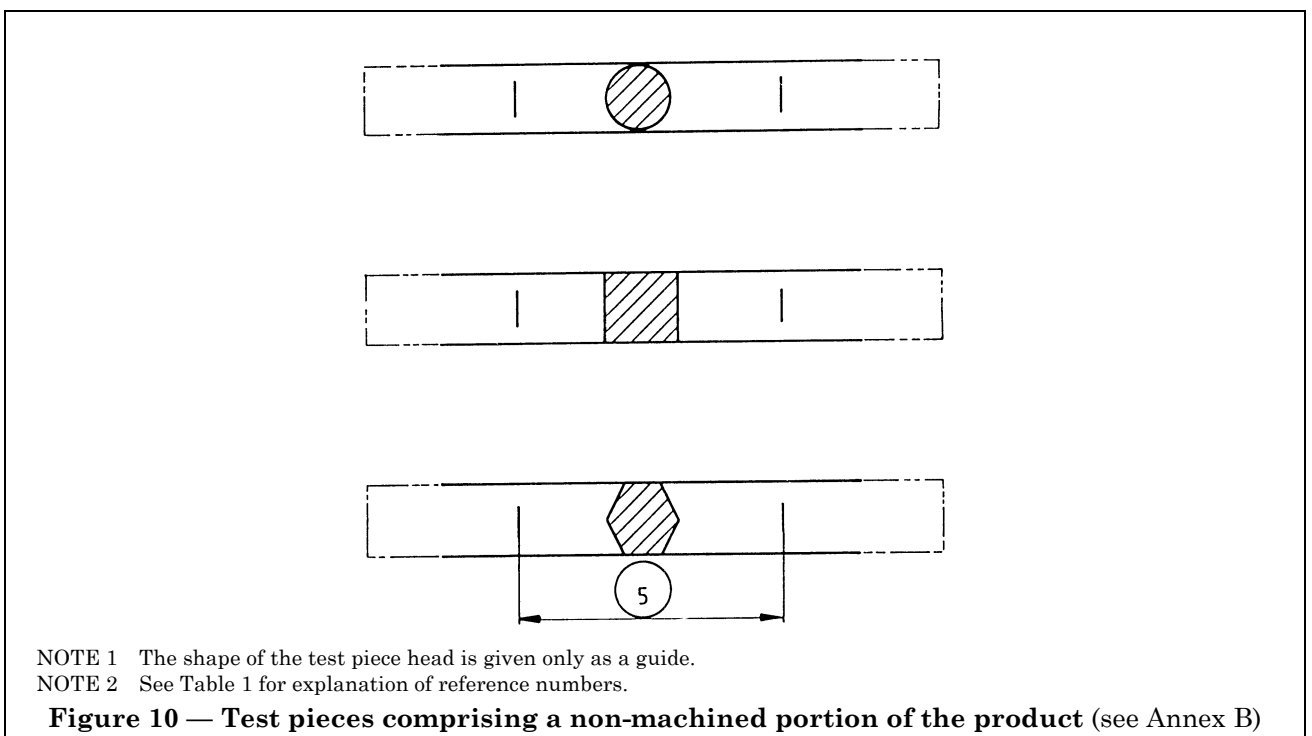
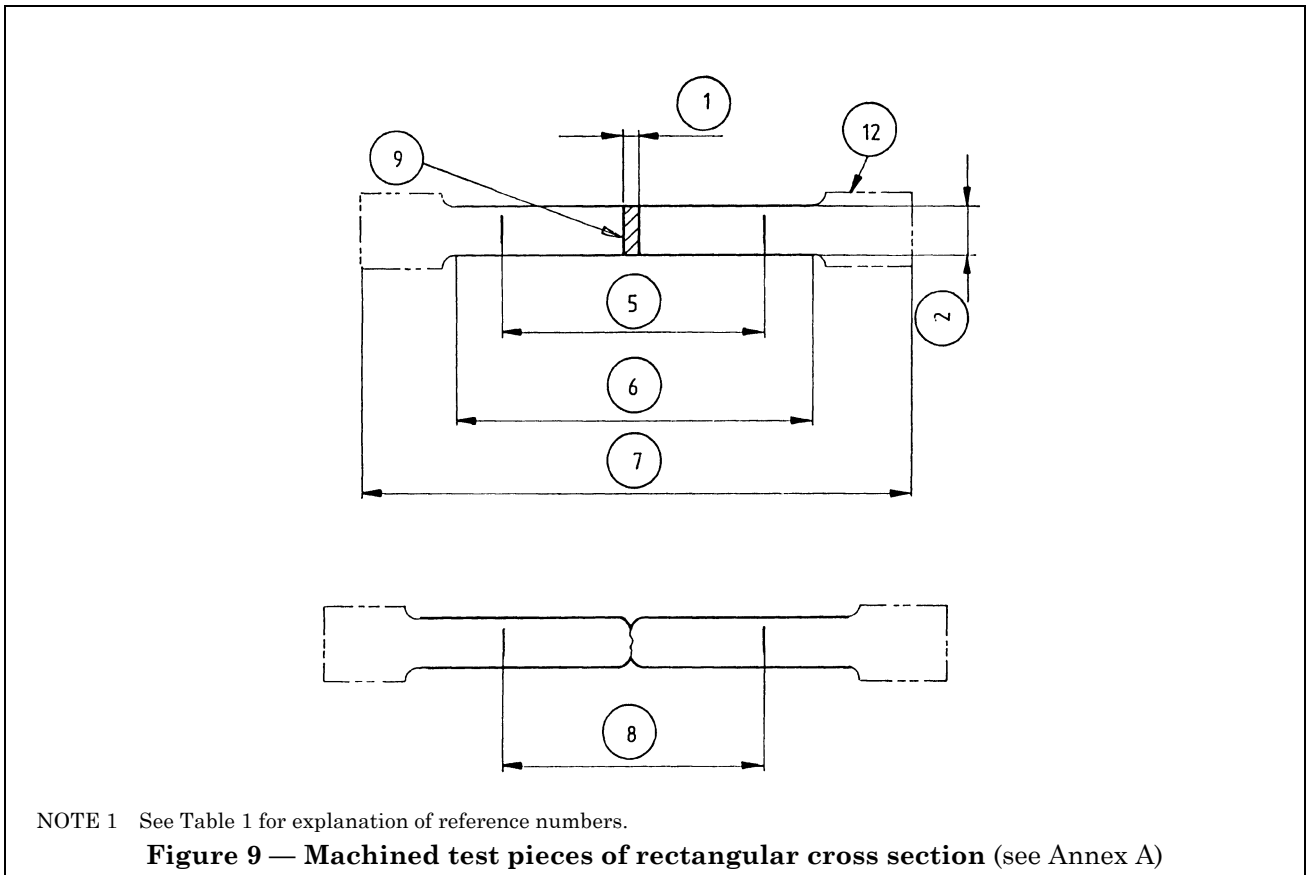

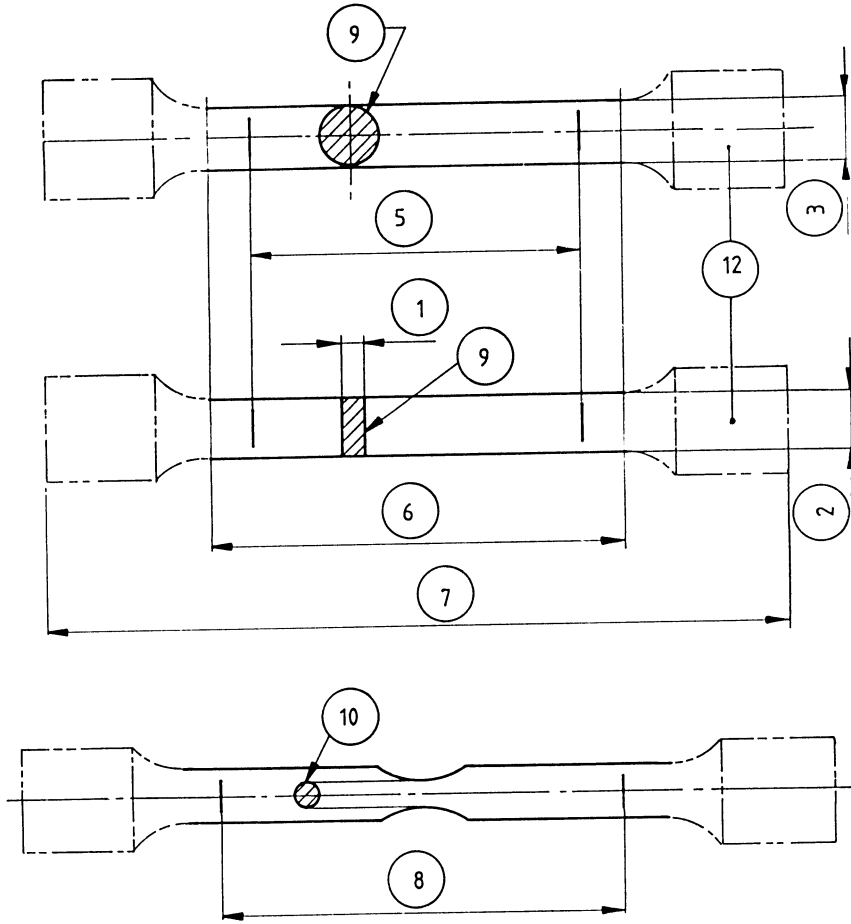

NOTE 1 The shape of the test piece heads is given only as a guide.  
 NOTE 2 See Table 1 for explanation of reference numbers.

**Figure 11 — Proportional test pieces** (see Annex C)

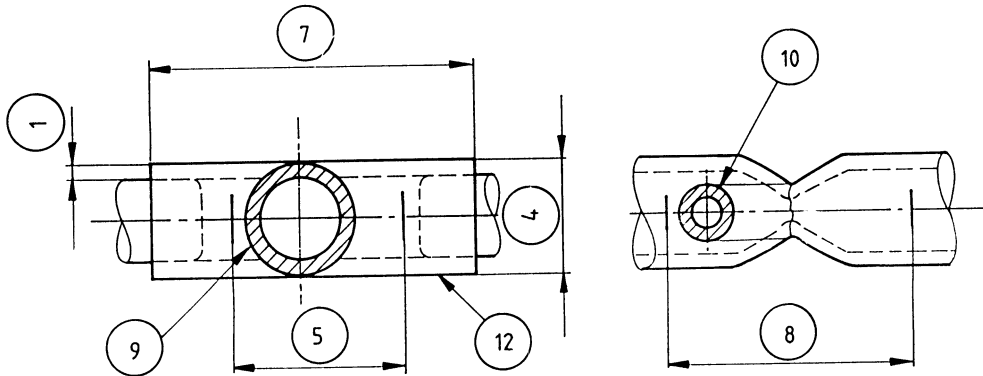

NOTE See Table 1 for explanation of reference numbers.

**Figure 12 — Test pieces comprising a length of tube** (see Annex D)

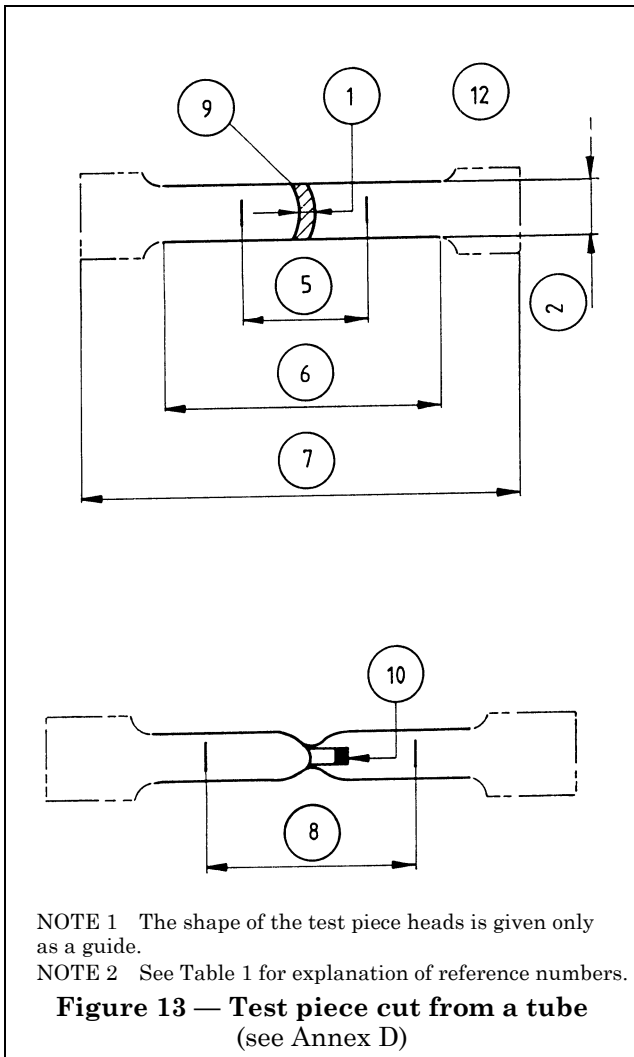

## Annex A (Normative annex)

### Types of test piece to be used for thin products: sheets, strips and flats between 0,1 mm and 3 mm thick

For products of less than 0,5 mm thickness, special precautions may be necessary.

#### A.1 Shape of the test piece

Generally, the test piece has gripped ends which are wider than the parallel length. The parallel length ( $L_0$ ) shall be connected to the ends by means of transition curves with a radius of at least 12 mm (see Figure 9). The width of these ends shall be at least 20 mm and not more than 40 mm.

The test piece may also consist of a strip with parallel sides. For products of width equal to or less than 20 mm, the width of the test piece may be the same as that of the product.

#### A.2 Dimensions of the test piece

##### A.2.1 Non-proportional test piece

The parallel length shall be not less than  $L_0 + b/2$ . In case of dispute, the length  $L_0 + 2b$  shall always be used unless there is insufficient material.

In the case of parallel-sided test pieces less than 20 mm wide, and unless otherwise specified in the product standard, the original gauge length ( $L_0$ ) shall be equal to 50 mm. For this type of test piece, the free length between the grips shall be equal to  $L_0 + 3b$ .

There are two types of non-proportional test pieces, with dimensions as given in Table A1.

When measuring the dimensions of each test piece, the tolerances on shape given in Table A2 shall apply.

In the case of test pieces where the width is the same as that of the product, the original cross-sectional area ( $S_0$ ) may be calculated on the basis of the measured dimensions of the test piece.

The nominal width of the test piece may be adopted, provided that the machining tolerances and tolerances on shape given in Table A2 have been complied with, to avoid measuring the width of the test piece at the time of the test.

Table A1 — Dimensions of test pieces

Dimensions in millimetres

Test piece type	Width $b$	Original gauge length $L_0$	Parallel length $L_c$	Minimum free length between the grips for parallel side test piece
1	$12,5 \pm 1$	50	75	87,5
2	$20 \pm 1$	80	120	140

Table A2 — Tolerances on the width of the test piece

Dimensions and tolerances in millimetres

Nominal width of the test piece	Machining tolerance <sup>a</sup>	Tolerance on shape
12,5	$\pm 0,09$	0,04
20	$\pm 0,10$	0,05

<sup>a</sup> These tolerances are applicable if the nominal value of the original cross-sectional area ( $S_0$ ) is to be included in the calculation without having to measure it.

**A.2.2 Proportional test pieces** For test pieces of shape as defined in A.2.1 it is possible to take the original gauge length ( $L_0$ ) as proportional to the original cross-sectional area ( $S_0$ ) using one of the relations

$$L_0 = 5,65 \sqrt{S_0} \quad \text{or}$$

$$L_0 = 11,3 \sqrt{S_0}$$

#### A.3 Preparation of test pieces

The test pieces shall be prepared so as not to affect the properties of the metal. Any areas which have been hardened by shearing or pressing shall be removed by machining.

For very thin materials, it is recommended that strips of identical widths should be cut and assembled into a bundle with intermediate layers of a paper which is resistant to the cutting oil. It is recommended that each small bundle of strips be assembled with a thicker strip on each side, before machining to the final dimensions of the test piece.

#### A.4 Determination of the original cross-sectional area ( $S_0$ )

The original cross-sectional area shall be calculated from measurements of the dimensions of the test piece.

The error in determining the original cross-sectional area shall not exceed  $\pm 2\%$ . As the greatest part of this error normally results from the measurement of the thickness of the test piece, the error in measurement of the width shall not exceed  $\pm 0,2\%$ .

## Annex B (Normative annex) Types of test piece to be used in the case of wire, bars and sections with a diameter or thickness of less than 4 mm

### B.1 Shape of the test piece

The test piece generally consists of an unmachined portion of the product (see Figure 10).

### B.2 Dimensions of the test piece

The original gauge length ( $L_0$ ) shall be taken as  $200 \pm 2$  mm or  $100 \pm 1$  mm or as  $11,3 \sqrt{S_0}$ <sup>6)</sup> in the case of products of diameter equal to or greater than 1 mm. The distance between the grips of the machine shall be equal to at least  $L_0 + 50$  mm, except in the case of small diameter wires where this distance can be taken as equal to  $L_0$ .

NOTE In cases where the percentage elongation after fracture is not to be determined, a distance between the grips of at least 50 mm may be used.

### B.3 Preparation of test pieces

If the product is delivered coiled, care shall be taken in straightening it.

### B.4 Determination of the original cross-sectional area ( $S_0$ )

The original cross-sectional area ( $S_0$ ) shall be determined to an accuracy of  $\pm 1$  %.

For products of circular cross-section, the original cross-sectional area may be calculated from the arithmetic mean of two measurements carried out in two perpendicular directions.

The original cross-sectional area may be determined from the mass of a known length and its density.

## Annex C (Normative annex) Types of test piece to be used in the case of sheets and flats of thickness equal to or greater than 3 mm, and wire, bars and sections of diameter or thickness equal to or greater than 4 mm

### C.1 Shape of the test piece

In general, the test piece is machined and the parallel length shall be connected by means of transition radii to the gripped ends which may be of any suitable shape for the grips of the test machine (see Figure 11).

The transition radius shall be at least:

- 2 mm for cylindrical test pieces
- 12 mm for test pieces of rectangular cross-section.

NOTE For certain materials, these values may be too low and likely to result in fracture of the test piece in the area of the transition.

Sections, bars, etc. may be tested unmachined if required.

The cross-section of the test piece may be circular, square, rectangular or, in special cases, of another shape.

For test pieces with a rectangular cross-section, it is recommended not to exceed a ratio of 8 : 1 between the width and thickness of the test piece.

In general, the diameter of the parallel length of machined cylindrical test pieces shall be not less than 4 mm.

### C.2 Dimensions of the test piece

#### C.2.1 *Parallel length of machined test piece*

The parallel length ( $L_c$ ) shall be at least equal to

- a)  $L_0 + d/2$  in the case of test pieces with circular cross-section;
- b)  $L_0 + 1,5 \sqrt{S_0}$  in the case of prismatic test pieces.

Depending on the type of test piece, the length  $L_0 + 2d$  or  $L_0 + \sqrt{S_0}$  shall be used in cases of dispute, unless there is insufficient material.

#### C.2.2 *Length of unmachined test piece*

The free length between the grips of the machine shall be adequate for the gauge marks to be a reasonable distance from these grips.

<sup>6)</sup> The requirement from clause 6.1.1 is not applicable in this case.

**C.2.3 Original gauge length ( $L_0$ )****C.2.3.1 Proportional test piece**

As a general rule, proportional test pieces are used where the original gauge length ( $L_0$ ) is related to the original cross-sectional area ( $S_0$ ) by the equation

$$L_0 = k \sqrt{S_0}$$

where  $k$  is equal to 5,65, which gives  $L_0 = 5d$  in the case of test pieces of circular cross-section.

Test pieces of circular cross-section shall preferably have the dimensions given in Table C1.

**C.2.3.2 Non-proportional test pieces**

Non-proportional test pieces may be used if specified by the product standard.

**Table C1 — Circular cross-section test pieces**

$k$	Diameter $d$ mm	Original cross-sectional area $S_0 =$ mm	Original gauge length $L_0 = \sqrt{S_0}$ mm	Minimum parallel length $L_c$ mm	Total length $L_t$
5,65	$20 \pm 0,150$	314,2	$100 \pm 1,0$	110	Depends on the method of fixing the test piece in the machine grips In principle: $L_t > L_c + 2d$
	$10 \pm 0,075$	78,5	$50 \pm 0,5$	55	
	$5 \pm 0,040$	19,6	$25 \pm 0,25$	28	

**Table C2 — Tolerances relating to the transverse dimensions of test pieces**

Dimensions and tolerances in millimetres

Designation	Nominal transverse dimension	Machining tolerance on the nominal dimension <sup>a</sup>	Tolerance on shape <sup>b</sup>
Diameter of machined test pieces of circular cross-section	$\geq 3$	$\pm 0,06$	0,03
	$\leq 6$	$\pm 0,075$	0,04
	$> 6$		
	$\leq 10$	$\pm 0,09$	0,04
	$> 10$		
	$\leq 18$		
	$> 18$		
Transverse dimensions of test pieces of rectangular cross-section machined on all four sides	$\leq 30$	$\pm 0,106$	0,06
	Same tolerances as for the diameter of test pieces of circular cross-section		
Transverse dimensions of test pieces of rectangular cross-section machined on only two opposite sides	$\geq 3$		0,18
	$\leq 6$		0,22
	$> 6$		
	$\leq 10$		0,27
	$> 10$		
	$\geq 18$		
	$> 18$		
$\leq 30$			
$> 30$			
	$\geq 50$	0,39	

<sup>a</sup> These tolerances are applicable if the nominal value of the original cross-sectional area ( $S_0$ ) is to be included in the calculation without having to measure it.

<sup>b</sup> Maximum deviation between the measurements of a specified transverse dimension along the entire parallel length ( $L_c$ ) of the test piece.

### C.3 Preparation of test pieces

The tolerances on the transverse dimensions of machined test pieces are given in Table C2.

An example of the application of these tolerances is given below:

#### a) Machining tolerances

If the nominal value of the original cross-sectional area ( $S_0$ ) is to be included in the calculation without having to measure it the value given in Table C2, for example  $\pm 0,075$  mm for a nominal diameter of 10 mm, means that no test piece shall have a diameter outside the two values given below

$$10 + 0,075 = 10,075 \text{ mm}$$

$$10 - 0,075 = 9,925 \text{ mm}$$

#### b) Tolerances on shape

The value given in Table C2 means that, for a test piece with a nominal diameter of 10 mm which satisfies the machining conditions given above, the deviation between the smallest and largest diameters measured shall not exceed 0,04 mm.

Consequently, if the minimum diameter of this test piece is 9,99 mm, its maximum diameter shall not exceed

$$9,99 + 0,04 = 10,03 \text{ mm}$$

### C.4 Determination of the cross-sectional area ( $S_0$ )

The nominal diameter can be used to calculate the original cross-sectional area of test pieces of circular cross-section which satisfy the tolerances given in Table C2. For all other shapes of test pieces, the original cross-sectional area shall be calculated from measurements of the appropriate dimensions, with an error not exceeding  $\pm 0,5$  % on each dimension.

## Annex D (Normative annex) Types of test piece to be used in the case of tubes

### D.1 Shape of the test piece

The test piece consists either of a length of tube or a longitudinal or transverse strip cut from the tube and having the full thickness of the wall of the tube (see Figure 12 and Figure 13), or of a test piece of circular cross-section machined from the wall of the tube.

Machined transverse, longitudinal and circular cross-section test pieces are described in Annex A for tube wall thickness less than 3 mm and in Annex C for thickness equal to or greater than 3 mm. The longitudinal strip is generally only used for tubes with a wall thickness of more than 0,5 mm.

For tests carried out on strip taken from welded tubes, unless otherwise specified in the product standard, the strip shall be cut at a position away from the weld bead.

### D.2 Dimensions of the test piece

#### D.2.1 Length of tube

In order to be gripped at both ends, the length of tube may be:

- fitted with plugs of appropriate diameter
- or fitted with two flat pieces approximately adapted to its diameter, then compressed
- or flattened.

Options b) and c) can only be applied to tubes of diameter 25 mm or less. In cases of dispute, only option a) shall be used.

Plugs or flat seals shall have a width at least equal to that of the grips and may project beyond the grips for a maximum length equal to the external diameter of the tube. Within this area, the shape of the plugs or seals shall have no effect on the deformation of the gauge length.

The free length between a plug or flat seal and the closest gauge mark shall be greater than  $D/4$ . In cases of dispute this length shall be the subject of an agreement between the parties.

#### D.2.2 Longitudinal or transverse strip

The parallel length ( $L_c$ ) of longitudinal strips shall not be flattened but the gripped ends may be flattened for gripping in the testing machine.

Transverse or longitudinal test piece dimensions other than those given in Annex A and Annex C can be specified in the product standard.

Special precautions shall be taken when straightening the transverse test pieces.

#### D.2.3 Machined circular cross-section of tube wall

The sampling of the test pieces may be specified in the product standard.

### D.3 Determination of the original cross-sectional area ( $S_0$ )

The original cross-sectional area of the test piece shall be determined to the nearest  $\pm 1$  %.

The original cross-sectional area of the length of tube or longitudinal or transverse strip may be determined from the mass of the test piece, the length of which has been measured, and from its density.

The original cross-sectional area ( $S_0$ ) of a test piece consisting of a longitudinal or transverse strip shall be calculated according to the following equation:

$$S_0 = \left(\frac{b}{4}\right) (D^2 - b^2)^{1/2} + \frac{D^2}{4} \arcsin \frac{b}{D} - \left(\frac{b}{4}\right) \times \\ \times [(D - 2a)^2 - b^2]^{1/2} - \\ - \left(\frac{D - 2a}{2}\right)^2 \arcsin \left(\frac{b}{D - 2a}\right)$$

where

- $a$  is the thickness of the tube wall;
- $b$  is the average width of the strips;
- $D$  is the external diameter.

The following simplified equations can be used for longitudinal or transverse test pieces:

$$\text{when } \frac{b}{D} < 0,25 \quad S_0 = ab \left[ 1 + \frac{b^2}{6D(D - 2a)} \right]$$

$$\text{when } \frac{b}{D} < 0,17 \quad S_0 = ab$$

In the case of a length of tube, the original cross-sectional area ( $S_0$ ) shall be calculated as follows:

$$S_0 = \pi a(D - a)$$

### Annex E (Normative annex) Measurement of percentage elongation after fracture, based on sub-division of the original gauge length

To avoid having to reject test pieces where the position of the fracture does not comply with the conditions of 11.1, the following method may be used, by agreement:

- a) before the test, sub-divide the original gauge length  $L_0$  into  $N$  equal parts;
- b) after the test, use the symbol X to denote the gauge mark of the shorter piece and the symbol Y to denote the gauge mark for the divisions shown on the longer piece (where the distance of the longer piece from the fracture is nearest to the distance of the fracture from gauge mark X).

If  $n$  is the number of intervals between X and Y, the elongation after fracture is determined as follows:

- 1) If  $N - n$  is an even number [see Figure E1 a)], measure the distance between X and Y and the distance from Y to the graduation mark Z located at

$$\frac{N - n}{2}$$

intervals beyond Y;

calculate the percentage elongation after fracture using the equation

$$A = \frac{XY + 2YZ - L_0}{L_0} \times 100$$

- 2) If  $N - n$  is an odd number [Figure E1 b)], measure the distance between X and Y and the distance from Y to the graduation marks Z' and Z'' located respectively at

$$\frac{N - n - 1}{2} \quad \text{and} \quad \frac{N - n + 1}{2}$$

intervals beyond Y;

calculate the percentage elongation after fracture using the equation

$$A = \frac{XY + YZ' + YZ'' - L_0}{L_0} \times 100$$

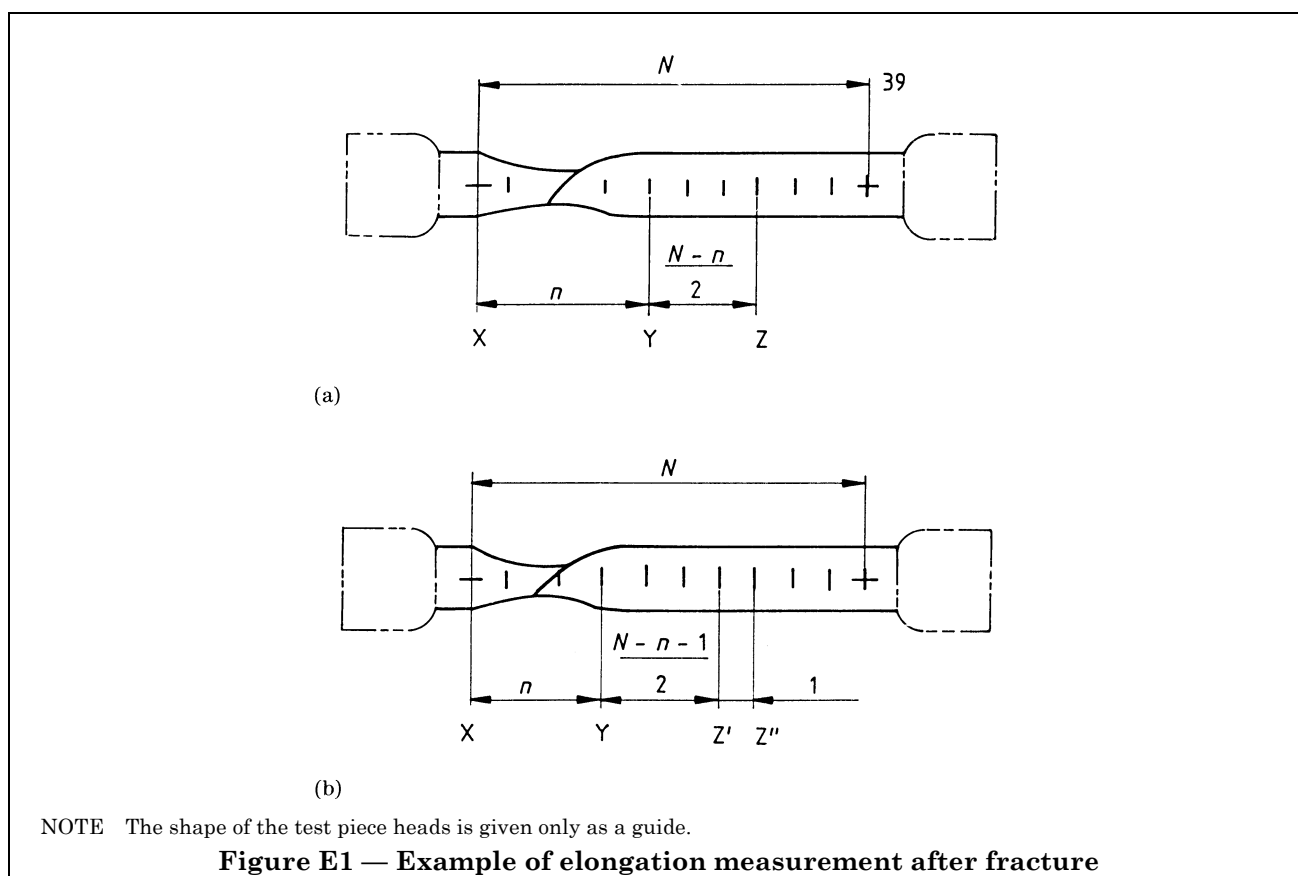

## Annex F (Informative annex) List of National Standards corresponding to reference Euronorm 18

Until EURONORM 18 is transformed into a European Standard, it is possible either to use it or to refer to the corresponding national standards, a list of which is given in Table F1.

## Annex G (Informative annex) Bibliography

### PUBLISHED PAPERS ON STRAIN RATE EFFECTS DURING TENSILE TESTING

*Baron, HG*

“Effect of Strain Rate on Tensile Stress-Strain Characteristics of Metals”, *Met. Treatment* 1962, 29, pp 25–30.

*Gillis, PG, Gross, TS*

“Effect of Strain Rate and Flow Properties”, Vol. 8 (Mechanical Testing) *ASM Metals Handbook*, Ninth Edition, 1985.

*Gray, TGF, Sharp, J*

“Influence of Machine Type and Strain Rate Interaction in Tension Testing”. *ASTM, STP 1025, Factors that affect the Precision of Mechanical Tests*, 1989. p187 – 205.

*Gray, TGF*

“Tensile testing”, Chapter 1 p1 – 42, *Mechanical Testing*, Edited by I Curbishley, Published by the Institute of Metals, 1988.

*Harding, J*

“Effect of temperature and strain rate on strength and ductility of four alloy steels”.

*Met. Technol.* 4(J) Jan. 1977, P6 – 16.

*Johnson, RF and Murray, JD*

“The effect of Rate of Straining on the 0.2 % Proof Stress and Lower Yield Stress of Steel”, *ISI Publication No. 97*, p79 – 85, 1967.

*Klueh, RL and Oakes, RE*

Strain Rate Effects on the Tensile Properties of a Bainitic 2 1/4 Cr1Mo Steel’, *Trans. ASME; Jnl of Eng. Matl. and Technology* October 1977, P350 – 358.

*Krabiell A and Dahl W*

“Influence of Temperature and Strain rate on the yield strength of Structural Steels of different strength”.

Arch. Eisenhüttenwes 52 (11) Nov. 1981 p429 – 436.

*Krabiell A and Dahl W*

“Influence of temperature and strain rate on the tensile and elongation properties of structural steels of different strengths”.

Arch. Eisenhüttenwes 52 (11) November 1981 p437 – 444.

*Leslie, WC and Sober, RJ*

“The Strength of Ferrite and Martensite on Functions of Composition, Temperature and Strain Rate”, Trans. ASM 1967, 60, p459.

*Nagata, N, Yoshida, S and Sekimo, Y*

“Strain Rate, Temperature and Grain Size Dependence of the LYS of Polycrystalline Iron”, Trans. ISIJ 1970, 10, p173

*Samanta, SK*

“On Relating the Flow Stress of Aluminium and Copper to Strain, Strain Rate and Temperature”, Int. J. Mech. Sci. 1969, 11, P433.

*Stelly, M*

“Influence of Deformation Rate on Tensile Behaviour of Five Steels” (in French)

Mem Etudes Scient. Rev. Metall 1980, 77 (7,8), P807.

*Watanabe, T*

“Effect of Strain Rate on Yield Behaviour of Cold Rolled Sheet Steel”, Trans.

ISIJ 1982, 22, P385.

**Table F1 — National standards corresponding to Euronorm 18**

EURONORM 18	Corresponding National Standard in					
	Germany	France	UK	Italy	Belgium	Sweden
a		NFA 03-111	b	UNI-EU 18	NBN A 03-001	SS 11 01 20 SS 11 01 25
<p><sup>a</sup> Since there is no DIN Standard corresponding to EU 18, requirements in respect of preparation and selection of test samples are contained in the appropriate product standards. For example, for structural purposes DIN 17 100, for use at high temperature DIN 17 155 and for use at low temperature DIN 17 280.</p> <p><sup>b</sup> Since there is no British Standard corresponding to EU 18, requirements in respect of preparation and selection of test samples are contained in the appropriate product standards.</p> <p>For example, for structural purposes BS 4360 for Pressure vessel purposes BS 1501</p>						

## National annex NA (informative)

The United Kingdom participation in the preparation of this European Standard was entrusted by the Iron and Steel and Non-ferrous Metals Standards Policy Committees (ISM/- and NFM/-) to Technical Committee ISM/NFM/4 upon which the following bodies were represented:

Aluminium Federation  
 British Gas plc  
 British Non-ferrous Metals Federation  
 British Railways Board  
 British Steel Industry  
 Copper Development Association  
 Department of Trade and Industry (National Measurement Accreditation Service)  
 Department of Trade and Industry (National Physical Laboratory)  
 ERA Technology Ltd.  
 GAMBICA (BEAMA Ltd.)  
 Ministry of Defence  
 Society of British Aerospace Companies Limited  
 University College London  
 Welding Institute

The following bodies were also represented in the drafting of the standard, through subcommittees and panels:

Association of Consulting Scientists  
 Department of Trade and Industry (National Engineering Laboratory)  
 Institute of Sheet Metal Engineering  
 Lloyd's Register of Shipping  
 Process Plant Association

## National annex NB (informative)

The British Standards corresponding to the European Standards referred to in the text are as follows:

European Standard	British Standard (content identical)
	BS EN 10002 Tensile testing of metallic materials
EN 10002-1	Part 1 Method of test at ambient temperature
EN 10002-2	Part 2 Verification of the force measuring system of the tensile testing machine
EN 10002-4 <sup>a</sup>	Part 4 Verification of extensometers used in uniaxial testing

<sup>a</sup> In preparation.

---

# BSI — British Standards Institution

BSI is the independent national body responsible for preparing British Standards. It presents the UK view on standards in Europe and at the international level. It is incorporated by Royal Charter.

## Revisions

British Standards are updated by amendment or revision. Users of British Standards should make sure that they possess the latest amendments or editions.

It is the constant aim of BSI to improve the quality of our products and services. We would be grateful if anyone finding an inaccuracy or ambiguity while using this British Standard would inform the Secretary of the technical committee responsible, the identity of which can be found on the inside front cover. Tel: 020 8996 9000. Fax: 020 8996 7400.

BSI offers members an individual updating service called PLUS which ensures that subscribers automatically receive the latest editions of standards.

## Buying standards

Orders for all BSI, international and foreign standards publications should be addressed to Customer Services. Tel: 020 8996 9001. Fax: 020 8996 7001.

In response to orders for international standards, it is BSI policy to supply the BSI implementation of those that have been published as British Standards, unless otherwise requested.

## Information on standards

BSI provides a wide range of information on national, European and international standards through its Library and its Technical Help to Exporters Service. Various BSI electronic information services are also available which give details on all its products and services. Contact the Information Centre. Tel: 020 8996 7111. Fax: 020 8996 7048.

Subscribing members of BSI are kept up to date with standards developments and receive substantial discounts on the purchase price of standards. For details of these and other benefits contact Membership Administration. Tel: 020 8996 7002. Fax: 020 8996 7001.

## Copyright

Copyright subsists in all BSI publications. BSI also holds the copyright, in the UK, of the publications of the international standardization bodies. Except as permitted under the Copyright, Designs and Patents Act 1988 no extract may be reproduced, stored in a retrieval system or transmitted in any form or by any means – electronic, photocopying, recording or otherwise – without prior written permission from BSI.

This does not preclude the free use, in the course of implementing the standard, of necessary details such as symbols, and size, type or grade designations. If these details are to be used for any other purpose than implementation then the prior written permission of BSI must be obtained.

If permission is granted, the terms may include royalty payments or a licensing agreement. Details and advice can be obtained from the Copyright Manager. Tel: 020 8996 7070.